

## INTRODUCTION

### Principle of operation

- The flow sensor measures the amount of gas or liquid that is flowing over a certain amount of time. Sensor system is divided into: Volume flow sensing and Mass flow sensor systems. Especially the gas flow sensors used in FA mainly uses a Mass based system, within which there are three other systems: the Heated system, Coriolis system, and the Vortex system.

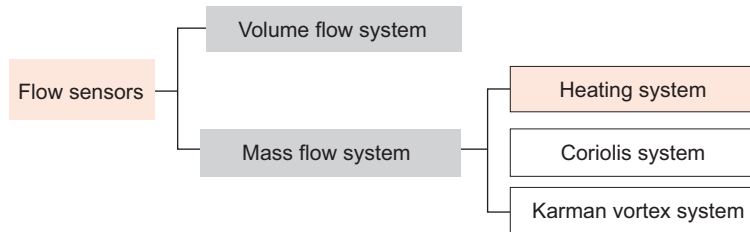

Panasonic Industrial Devices SUNX's flow sensor uses the heating system mass flow system.

### Heating system flow sensor principles and characteristics

- Panasonic Industrial Devices SUNX's heating system flow sensor uses a silicone sensor chip made with silicone micro manufacturing technology. The heater inside of the silicone sensor chip is insulated against heat from the main silicone board, so because the amount of heat is so small it is incredibly sensitive and quick. If the bridge circuit is set up as below so that the heater and ambient temperature sensor are on the bridge circuit, then the temperature difference between the ambient sensor and heater will be kept constant by the control system. The heater is made from platinum because of its proportionate resistance values to temperature changes. When dealing with gas flow the heater must be kept at a constant temperature, so the heat that is taken from the heater is proportionately replenished with voltage from the bridge circuit. Using this control system the sensing of the flow rate can be protected from the influence of temperature and pressure changes. Also, this control system can be used for comparatively high flow rates.

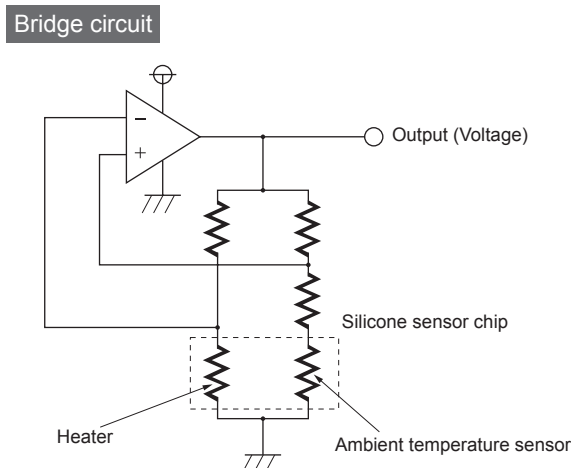
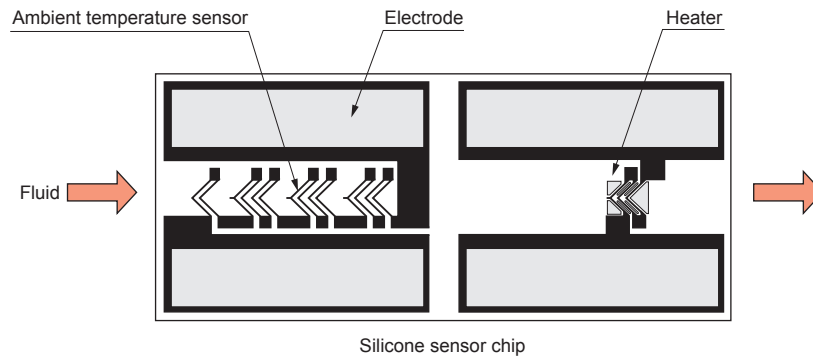

## TYPES OF SENSORS

### Classification

#### ① Classification by applicable fluid

- Fluids subject to flow rate control include air, water, oil etc., but the Panasonic Industrial Devices SUNX's flow sensor is made for use with purified air, pressurized air, and nitrogen gas. We cannot guarantee the precision of the measurements if it is used with other fluids, so please refrain from the use of non specified fluids.



Type	Description
For use with purified air, pressurized air, nitrogen gas	Uses the silicone sensor chip. Can be used with purified air (JIS B 8392-1.1.1 to 5.6.2 designated air), pressurized air (JIS B 8392-1.1.1 to 1.6.2 designated air), and nitrogen gas.

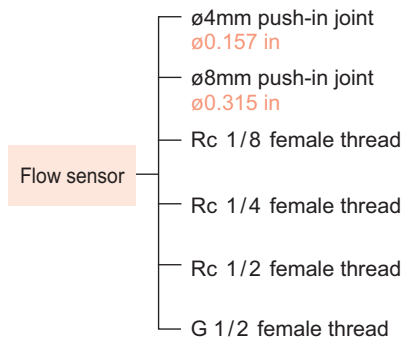

#### ② Classification by pressure port

- The required port differs with the piping done. If the required shape or size of the port differs, it is necessary to use attachments.







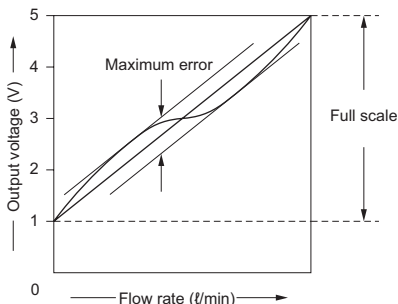
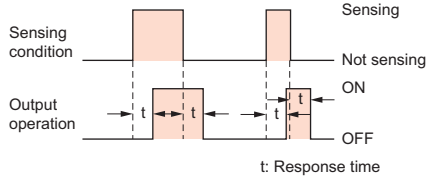

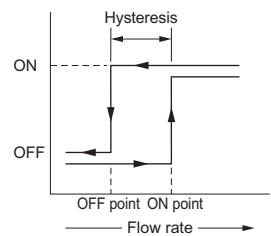
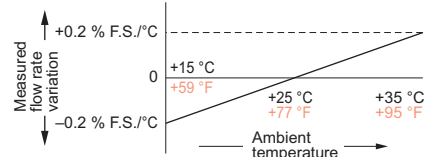
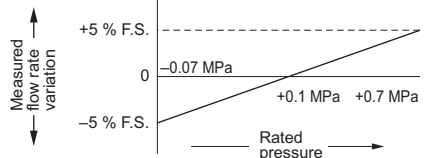





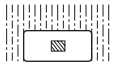
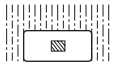

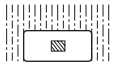















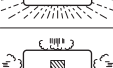
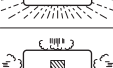

Type	Description
ø4mm ø0.157 in push-in joint ø8mm ø0.315 in push-in joint	 <ul style="list-style-type: none"> <li>Easy connection with a tube</li> <li>Used for low flow rate applications</li> <li>Commonly used in Japan</li> </ul>
Rc 1/8 female thread Rc 1/4 female thread Rc 1/2 female thread	 <ul style="list-style-type: none"> <li>Tapered female thread</li> <li>Used for high flow rate applications</li> <li>Commonly used in Japan</li> </ul>
G 1/2 female thread	 <ul style="list-style-type: none"> <li>Straight female thread</li> <li>Fairly air-tight for low flow rate applications, and easily connectable</li> <li>Commonly used in Europe</li> </ul>

## GLOSSARY

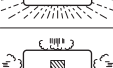
Term	Description
Designated flow rate range	Accurate over the specified flow rate range. The mass flow rate is measured so that the flow rate is not under the influence of temperature or pressure. Measurement units are in l/min., however this is displayed as calculated when the mass flow rate is at +20 °C +68 °F, and air pressure is at 1 (101 kPa).
Rated pressure range	Pressure range over which specified capabilities can be maintained.
Pressure withstandability	The maximum pressure outside the rated pressure range which can be applied to the pressure sensor without its performance deteriorating when the pressure is brought back to the rated pressure range.
Repeatability	Variations in ON level when the applied flow rate is repeatedly changed to switch the output ON / OFF under constant supply voltage and temperature. It is expressed as a percentage of the full scale.  $\frac{\text{Maximum operating point} - \text{Minimum operating point}}{\text{Rated flow rate range}} \times 100 (\% \text{ F.S.})$
Linearity	Although the analog output changes almost linearly with respect to the measured flow rate, there is a slight deviation from an ideal straight line. This deviation, expressed as a percentage of full-scale, is the linearity.  
Response time	The time delay between the change in the sensing condition and the turning of the output to ON or OFF.  

Term	Description
Hysteresis	Difference in flow rate at which the output turns ON and OFF.  
Temperature characteristics	They are specified as the variation in the measured flow rate which occurs when the ambient temperature is varied from +15 °C +59 °F to +35 °C +95 °F, taking the flow measured at +25 °C +77 °F as the reference. The variation is expressed as a percentage of full scale.   <p>However, the graph shows typical values. There may be slight variations depending on the product.</p>
Pressure characteristics	They are specified as the variation in the measured flow rate which occurs when the pressure is varied at the rated pressure range, taking the flow rate measured at +0.1 MPa as the reference. The variation is expressed as a percentage of full scale.   <p>However, the graph shows typical values. There may be slight variations depending on the product.</p>
Acoustic velocity	Refers to the air mediums fastest possible velocity. Mach number 1. In the earth's atmosphere when temperature is constant at +15 °C +59 °F the speed is approx. 340 m/s.
Sub-acoustic velocity	It is slower than the speed of sound, though not by much. Lower than Mach number 0.75.

GLOSSARY

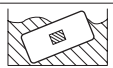
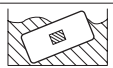
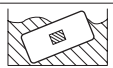
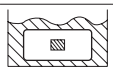
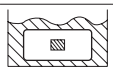
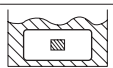
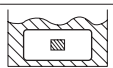
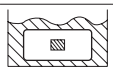
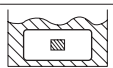
Term	Description									
Protection	Degree of protection against water, human body and solid foreign material. Protection degree is specified as per IEC (International Electrotechnical Commission).									
	<p><b>IEC standard</b></p>									
	<p>IP□□                      └─── Second figure . . . Protection against water penetration                      └─── First figure . . . . . Protection against human body and solid foreign material</p>									
	<ul style="list-style-type: none"> <li>• Protection degree specified by the first figure</li> <li>• Protection degree specified by the second figure</li> </ul>									
	<table border="1"> <thead> <tr> <th>First figure</th> <th>Description</th> </tr> </thead> <tbody> <tr> <td>0</td> <td>No protection</td> </tr> </tbody> </table>	First figure	Description	0	No protection	<table border="1"> <thead> <tr> <th>Second figure</th> <th>Description</th> </tr> </thead> <tbody> <tr> <td>0</td> <td>No protection</td> </tr> </tbody> </table>	Second figure	Description	0	No protection
	First figure	Description								
	0	No protection								
	Second figure	Description								
	0	No protection								
	<table border="1"> <tbody> <tr> <td>1</td> <td>Protection against contact with internal live parts by a human hand (ø50 mm ø1.969 in)</td> <td></td> </tr> </tbody> </table>	1	Protection against contact with internal live parts by a human hand (ø50 mm ø1.969 in)		<table border="1"> <tbody> <tr> <td>1</td> <td>No harmful effect due to vertically falling water drops</td> <td></td> </tr> </tbody> </table>	1	No harmful effect due to vertically falling water drops			
1	Protection against contact with internal live parts by a human hand (ø50 mm ø1.969 in)									
1	No harmful effect due to vertically falling water drops									
<table border="1"> <tbody> <tr> <td>2</td> <td>Protection against contact with internal live parts by a human finger (ø12 mm ø0.472 in)</td> <td></td> </tr> </tbody> </table>	2	Protection against contact with internal live parts by a human finger (ø12 mm ø0.472 in)		<table border="1"> <tbody> <tr> <td>2</td> <td>No harmful effect due to water drops falling from a range 15° wider than the vertical</td> <td></td> </tr> </tbody> </table>	2	No harmful effect due to water drops falling from a range 15° wider than the vertical				
2	Protection against contact with internal live parts by a human finger (ø12 mm ø0.472 in)									
2	No harmful effect due to water drops falling from a range 15° wider than the vertical									
<table border="1"> <tbody> <tr> <td>3</td> <td>Protection against contact with internal live parts by a solid object more than 2.5 mm 0.098 in in thickness or diameter</td> <td></td> </tr> </tbody> </table>	3	Protection against contact with internal live parts by a solid object more than 2.5 mm 0.098 in in thickness or diameter		<table border="1"> <tbody> <tr> <td>3</td> <td>No harmful effect due to water drops falling from a range 60° wider than the vertical</td> <td></td> </tr> </tbody> </table>	3	No harmful effect due to water drops falling from a range 60° wider than the vertical				
3	Protection against contact with internal live parts by a solid object more than 2.5 mm 0.098 in in thickness or diameter									
3	No harmful effect due to water drops falling from a range 60° wider than the vertical									
<table border="1"> <tbody> <tr> <td>4</td> <td>Protection against contact with internal live parts by a solid object more than 1.0 mm 0.039 in in thickness or diameter</td> <td></td> </tr> </tbody> </table>	4	Protection against contact with internal live parts by a solid object more than 1.0 mm 0.039 in in thickness or diameter		<table border="1"> <tbody> <tr> <td>4</td> <td>No harmful effect due to water splashes from any direction</td> <td></td> </tr> </tbody> </table>	4	No harmful effect due to water splashes from any direction				
4	Protection against contact with internal live parts by a solid object more than 1.0 mm 0.039 in in thickness or diameter									
4	No harmful effect due to water splashes from any direction									
<table border="1"> <tbody> <tr> <td>5</td> <td>Protection against dust penetration which can affect operation</td> <td></td> </tr> </tbody> </table>	5	Protection against dust penetration which can affect operation		<table border="1"> <tbody> <tr> <td>5</td> <td>No harmful effect due to direct water jet from any direction</td> <td></td> </tr> </tbody> </table>	5	No harmful effect due to direct water jet from any direction				
5	Protection against dust penetration which can affect operation									
5	No harmful effect due to direct water jet from any direction									
<table border="1"> <tbody> <tr> <td>6</td> <td>Complete protection against dust penetration</td> <td></td> </tr> </tbody> </table>	6	Complete protection against dust penetration		<table border="1"> <tbody> <tr> <td>6</td> <td>No water penetration due to direct water jet from any direction</td> <td></td> </tr> </tbody> </table>	6	No water penetration due to direct water jet from any direction				
6	Complete protection against dust penetration									
6	No water penetration due to direct water jet from any direction									
<p>Note: The IEC standard prescribes test procedures for each protection degree given above. The protection degree specified in the product specifications has been decided according to these tests.</p>										
<p><b>IP67G / IP68G</b></p> <p>This specifies protection against oil in addition to IP67 / IP68 protection of IEC standards. It specifies that oil drops or bubbles should not enter from any direction.</p>	<table border="1"> <tbody> <tr> <td>7</td> <td>No water penetration due to immersion in water under specified conditions</td> <td></td> </tr> </tbody> </table>	7	No water penetration due to immersion in water under specified conditions							
7	No water penetration due to immersion in water under specified conditions									
<table border="1"> <tbody> <tr> <td>8</td> <td>No water penetration during immersion, even under conditions that are more harsh than the ones in No.7.</td> <td></td> </tr> </tbody> </table>	8	No water penetration during immersion, even under conditions that are more harsh than the ones in No.7.		<table border="1"> <tbody> <tr> <td>8</td> <td>No water penetration during immersion, even under conditions that are more harsh than the ones in No.7.</td> <td></td> </tr> </tbody> </table>	8	No water penetration during immersion, even under conditions that are more harsh than the ones in No.7.				
8	No water penetration during immersion, even under conditions that are more harsh than the ones in No.7.									
8	No water penetration during immersion, even under conditions that are more harsh than the ones in No.7.									

- Photoelectric Sensors
- Pressure Sensors
- Flow Sensors
- Inductive Proximity Sensors
- Displacement Sensors
- Electrostatic Sensors
- Static Removers
- About Laser Beam
- General Precautions

## FUNCTIONS

Function	Description
Peak hold & bottom hold function	Peak hold and bottom hold functions enable the display of the peak value (maximum flow rate value) and the bottom value (minimum flow rate value) of the varying measured flow rate. These functions are convenient for finding the flow rate variation range or determining the reference for flow rate settings.
Forcible output function	The comparative output1, 2 forceful options can be switched ON. This is convenient during output operation confirmation and when starting work on a project, beginning operations.

## PRECAUTIONS FOR PROPER USE

### Flow sensor selection

- If using a flow sensor for tasks such as checking suction and release from suction nozzles and sensing leaks, use the flow rate range setting table as a guide. The effective cross-section area of the nozzle (pinhole) and the difference in pressure inside and outside the nozzle can be used to calculate the flow rate.

- For  $P_1 \geq 1.89 \times P_2$  (acoustic velocity)  $Q = 113.2 \times S \times P_1$   
 $P_2$ : Vacuum  $P_1$ : Pressurized
- For  $P_1 < 1.89 \times P_2$  (sub-acoustic velocity)  $Q = 226.4 \times S \times \sqrt{P_2(P_1 - P_2)}$   
 $Q$ : Flow rate  $\ell/\text{min}$ .  
 $P_1$ : Absolute pressure at primary side (MPa)  
 $P_2$ : Absolute pressure at secondary side (MPa)  
 $S$ : Effective cross-section area of nozzle (pinhole)  $\text{mm}^2$

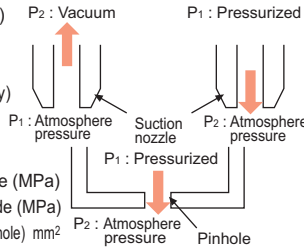

### <Calculation example>

The flow rate calculation value for a nozzle diameter of  $\varnothing 0.1$  to  $\varnothing 2.0$  mm  $\varnothing 0.004$  to  $\varnothing 0.079$  in when  $P_2$  is varied is shown in the table below.

	P1(MPa) Absolute pressure	P1(MPa) Gauge pressure	P2(MPa) Absolute pressure	P2(MPa) Gauge pressure	Acoustic velocity / Sub-acoustic velocity	Calculated flow rate value ( $\ell/\text{min}$ )									
						$\varnothing 0.1$ mm $\varnothing 0.004$ in	$\varnothing 0.2$ mm $\varnothing 0.008$ in	$\varnothing 0.3$ mm $\varnothing 0.012$ in	$\varnothing 0.4$ mm $\varnothing 0.016$ in	$\varnothing 0.5$ mm $\varnothing 0.020$ in	$\varnothing 0.7$ mm $\varnothing 0.027$ in	$\varnothing 1.0$ mm $\varnothing 0.039$ in	$\varnothing 1.5$ mm $\varnothing 0.059$ in	$\varnothing 2.0$ mm $\varnothing 0.079$ in	
Suction	0.1013	0	0.0313	-0.07	Acoustic velocity	0.090	0.360	0.810	1.440	2.250	4.411	9.002	20.254	36.007	
	0.1013	0	0.0413	-0.06	Acoustic velocity	0.090	0.360	0.810	1.440	2.250	4.411	9.002	20.254	36.007	
	0.1013	0	0.0513	-0.05	Acoustic velocity	0.090	0.360	0.810	1.440	2.250	4.411	9.002	20.254	36.007	
	0.1013	0	0.0613	-0.04	Sub-acoustic velocity	0.088	0.352	0.792	1.408	2.200	4.312	8.800	19.801	35.202	
	0.1013	0	0.0713	-0.03	Sub-acoustic velocity	0.082	0.329	0.740	1.315	2.055	4.028	8.220	18.494	32.878	
	0.1013	0	0.0813	-0.02	Sub-acoustic velocity	0.072	0.287	0.645	1.147	1.792	3.512	7.166	16.125	28.666	
Blow (leakage detection)	0.1013	0	0.0913	-0.01	Sub-acoustic velocity	0.054	0.215	0.483	0.859	1.343	2.631	5.370	12.083	21.480	
	0.1113	0.01	0.1013	0	Sub-acoustic velocity	0.057	0.226	0.509	0.905	1.414	2.772	5.657	12.727	22.626	
	0.1213	0.02	0.1013	0	Sub-acoustic velocity	0.080	0.320	0.720	1.280	2.000	3.920	8.000	17.999	31.998	
	0.1413	0.04	0.1013	0	Sub-acoustic velocity	0.113	0.453	1.018	1.810	2.828	5.543	11.313	25.454	45.252	
	0.1613	0.06	0.1013	0	Sub-acoustic velocity	0.139	0.554	1.247	2.217	3.464	6.789	13.856	31.175	55.423	
	0.1813	0.08	0.1013	0	Sub-acoustic velocity	0.160	0.640	1.440	2.560	4.000	7.840	15.999	35.998	63.996	
	0.2013	0.1	0.1013	0	Acoustic velocity	0.179	0.716	1.610	2.862	4.472	8.765	17.888	40.248	71.552	
	0.3013	0.2	0.1013	0	Acoustic velocity	0.268	1.071	2.410	4.284	6.694	13.119	26.774	60.242	107.096	
	0.4013	0.3	0.1013	0	Acoustic velocity	0.357	1.426	3.209	5.706	8.915	17.474	35.660	80.236	142.641	
	0.5013	0.4	0.1013	0	Acoustic velocity	0.445	1.782	4.009	7.127	11.137	21.828	44.547	100.230	178.186	
0.6013	0.5	0.1013	0	Acoustic velocity	0.534	2.137	4.809	8.549	13.358	26.182	53.433	120.224	213.731		

- Notes:
- In case of any leakage from tubes, etc., actual values will differ greatly from calculated values. When measuring flows, make sure that there is no leakage from any tubes.
  - In case of any points in the tubes which are narrower than the diameter of the suction nozzle, flow rate will be restricted and may turn out to be lower than the calculated values.  
In addition, suction verification may not be possible in such cases.
  - The effective cross-section area is a guide only. If the nozzle is long and narrow, the effective cross-section area may be smaller than the area at the tip of the nozzle.
  - Response times are determined by the internal volume of the tube from the flow sensor to the suction nozzle (pinhole). If carrying out high-speed sensing, reduce the internal volume of the tube as much as possible such as by locating the flow sensor as close as possible to the suction nozzle.

## PRECAUTIONS FOR PROPER USE

### Applicable fluid

- Flow sensor is for use in air and nitrogen only. Do not use the product for other fluids since the sensing accuracy cannot be guaranteed.
- Use the clean air complied with JIS B 8392-1.1.1 to 5.6.2 and the compressed air complies with JIS B 8392-1.1.1 to 1.6.2.
- Install a filter, an air dryer and an oil mist filter (micro-alescer) onto the primary side (upstream) of flow sensor since the compressed air from the compressor contains drain (water, oil oxide and foreign materials, etc.). Mesh (wire net) in the port of flow sensor is used to rectify the flow rate in the pipe. Always install a filter to flow sensor since this mesh is not a filter to remove foreign materials.

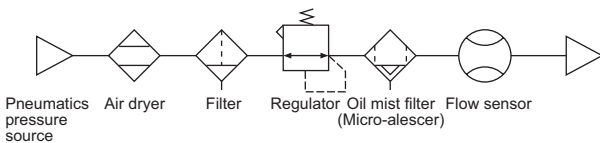

- When using a valve on the primary side of the flow sensor, only use an oil-prohibit specification valve. Flow sensor may malfunction or break if subject to splattering grease or oil, etc.

### Concerning flow rate measurement units

- The mass flow rate is measured so that the flow rate is not under the influence of temperature or pressure. Measurement units are in l/min., however this is displayed as calculated when the mass flow rate is at +20 °C +68 °F, and air pressure is at 1 atm.(101 kPa).

### Wiring

- Make sure that the power supply is off while wiring.
- Verify that the supply voltage variation is within the rating.
- Take care that if applying voltage exceeding the rated range or connecting to AC power supply, the product may break or burn.
- If power is supplied from a commercial switching regulator, ensure that the frame ground (F.G.) terminal of the power supply is connected to an actual ground.
- Ensure that an isolation transformer is utilized for the DC power supply. If an autotransformer is utilized, the main body or power supply may be damaged
- In case noise generating equipment (switching regulator, inverter motor, etc.) is used in the vicinity of this sensor, connect the frame ground (F.G.) terminal of the equipment to an actual ground.
- If the used power supply generates a surge, connect a surge absorber to the power supply to absorb the surge.
- Do not run the wires together with high-voltage lines or power lines or put them in the same raceway. This can cause malfunction due to induction.
- In order to reduce noise, make the wiring as short as possible.
- Make sure that stress by forcible bend or pulling is not applied directly to the sensor cable joint.

### Other precautions

- Our products have been developed / produced for industrial use only.
- Use within the rated flow rate range.
- Do not apply pressure exceeding the pressure withstandability value.
- Accuracy of the analogue voltage output is influenced by self-heating by applying current other than the temperature characteristics. Standby time (5 min. or more after applying current) should be taken when using the product.
- The specification may not be satisfied in a strong magnetic field.
- Avoid dust, dirt, and steam.
- Take care that if foreign materials are mixed in the sensing part, the product may break.
- Take care that the sensor does not come in direct contact with water, oil, grease, or organic solvents, such as, thinner, etc.
- Do not operate the keys with pointed or sharp objects.
- The usage environment should be within the ranges described in the specifications. Use sensors within the range shown in the white part of the ambient temperature / humidity graph below and also within the certified ambient temperature and humidity range of each product. When using sensors within the range shown in the diagonal line shaded part of the graph, there is a possibility that condensation may occur depending on changes in the ambient temperature. Please be careful not to let this happen. Furthermore, pay attention that freezing does not occur when using below 0 °C +32 °F. Please avoid condensation and freezing when storing the product as well.

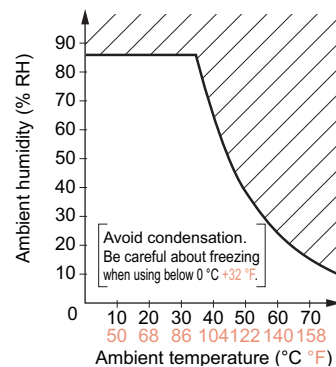

- Photoelectric Sensors
- Pressure Sensors
- Flow Sensors**
- Inductive Proximity Sensors
- Displacement Sensors
- Electrostatic Sensors
- Static Removers
- About Laser Beam
- General Precautions